

SERIES F 7411 - JIS 5K
Bronze Globe Check Valve
Union Bonnet

SERIES F 7412 - JIS 5K
Bronze Angle Check Valve
Union Bonnet

Manufactured in accordance to JIS F 7400

Flanges as per JIS B 2240 - 5K

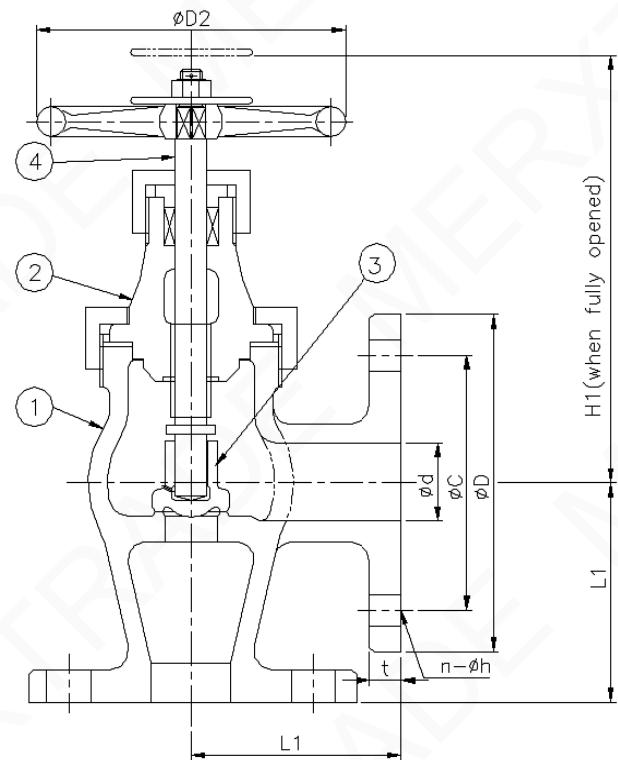
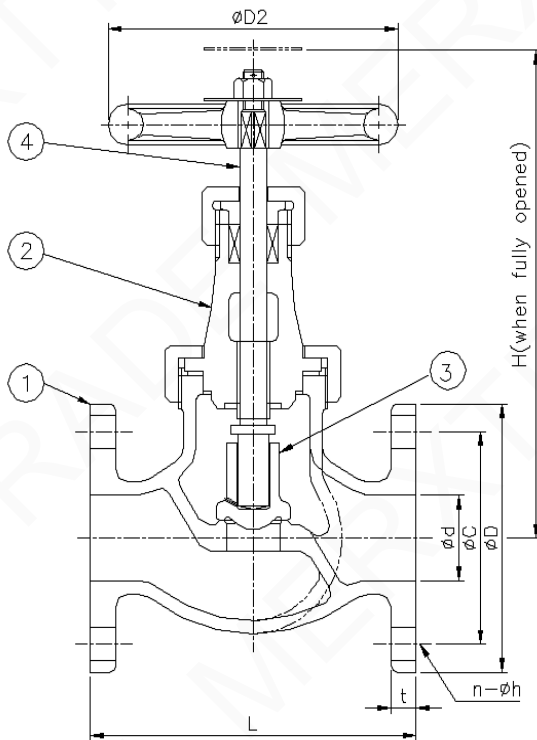

SERIES F 7411 Globe Valve

SERIES F 7412 Angle Valve

Part No.	Material
1 - Body	Bronze
2 - Bonnet	Bronze
3 - Disc	Bronze
4 - Stem	Brass

Test Pressure MPa[Kgf/cm ²]	
Body	1.05 [10.5]
Seat	0.77 [7.7]

SIZE	d	L	L1	D	C	n-h	t	H	H1	D2	F7411 (Kg)	F7412 (Kg)
015	15	100	55	80	60	4-12	9	150	140	80	2.12	2.07
020	20	110	60	85	65	4-12	10	160	150	100	2.91	2.81
025	25	120	65	95	75	4-12	10	185	170	125	3.82	3.67
032	32	140	80	115	90	4-15	12	190	170	125	5.09	4.85
040	40	160	85	120	95	4-15	12	205	180	140	6.71	6.17